

PLANTA INFERIOR
CASTELO D'ÁGUA CONCRETO
ESCALA 1/50

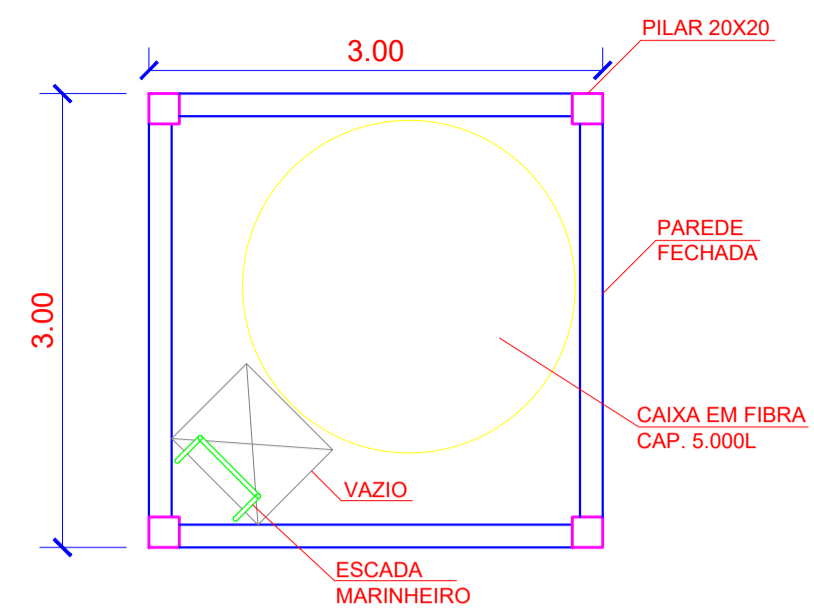

PLANTA SUPERIOR
CASTELO D'ÁGUA CONCRETO
ESCALA 1/50

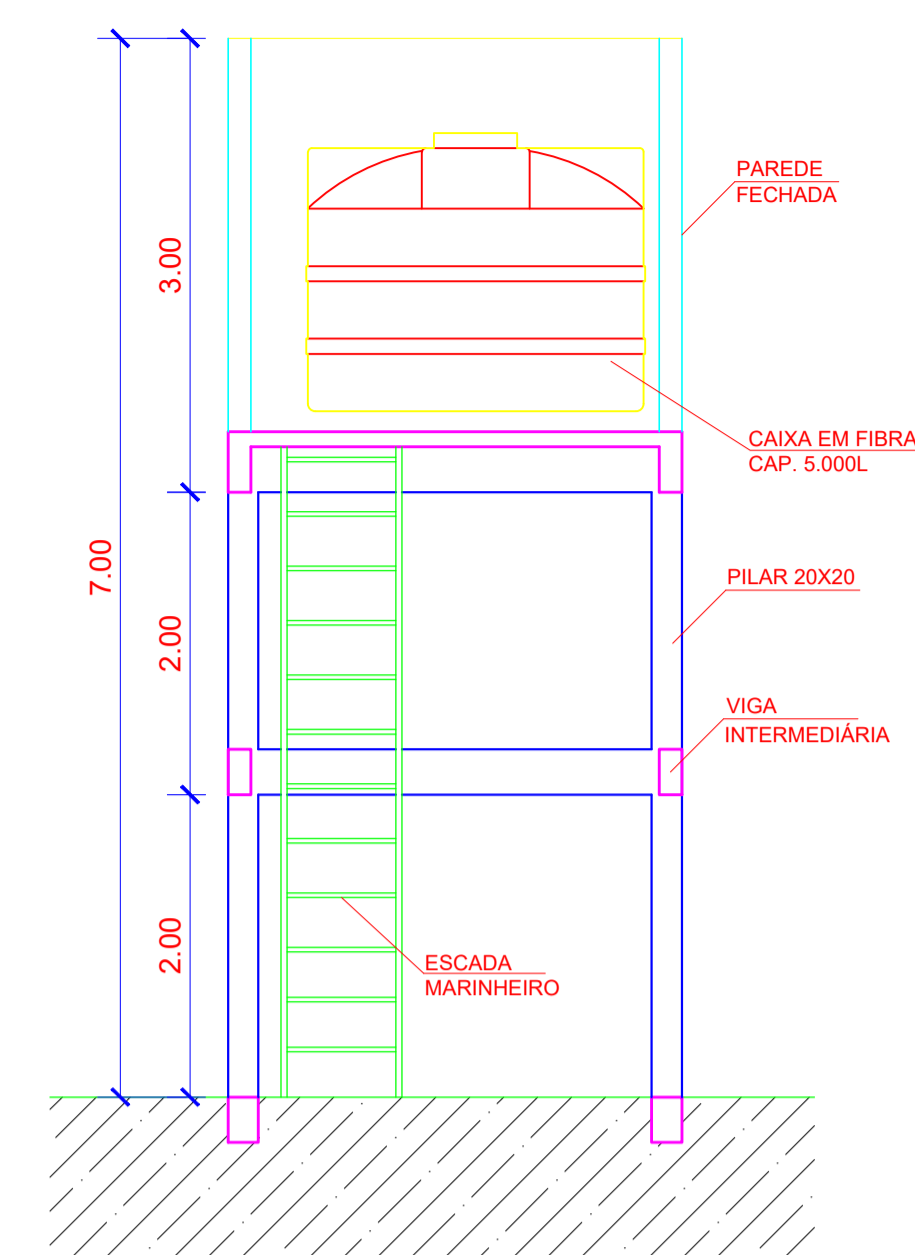

CORTE AA
CASTELO D'ÁGUA CONCRETO
ESCALA 1/50

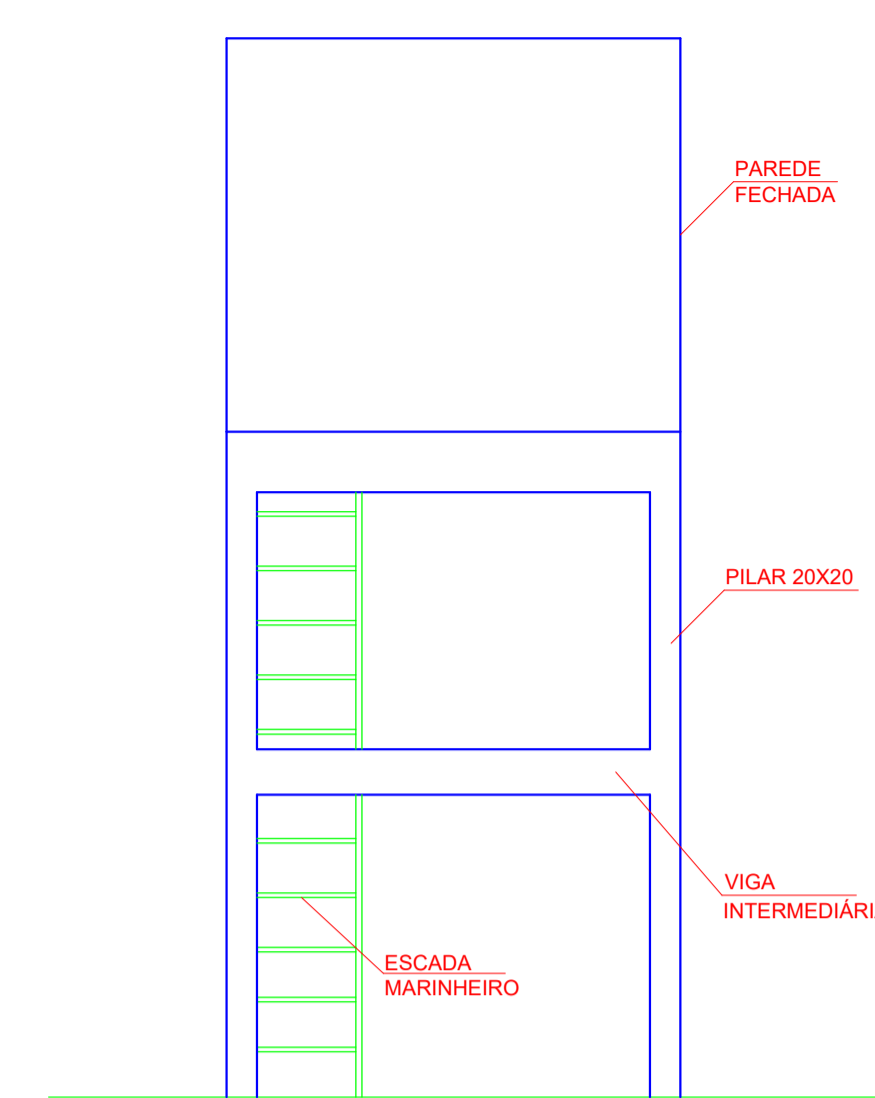

VISTA
CASTELO D'ÁGUA CONCRETO
ESCALA 1/50

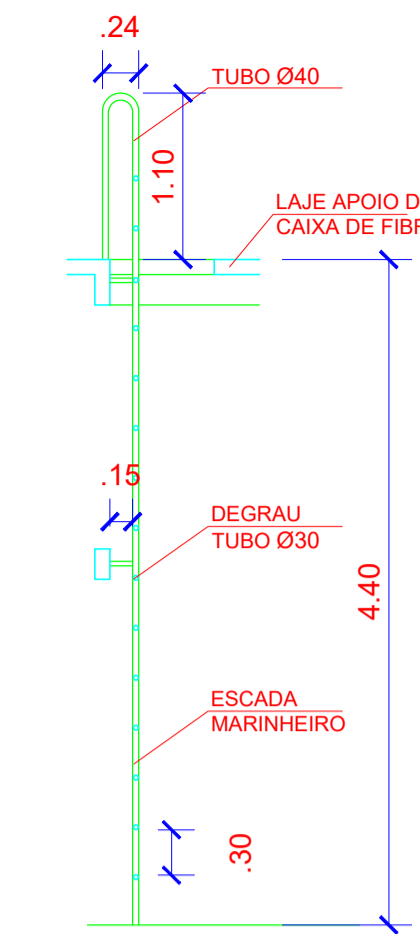

VISTA LATERAL
ESCADA MARINHEIRO
ESCALA 1/50

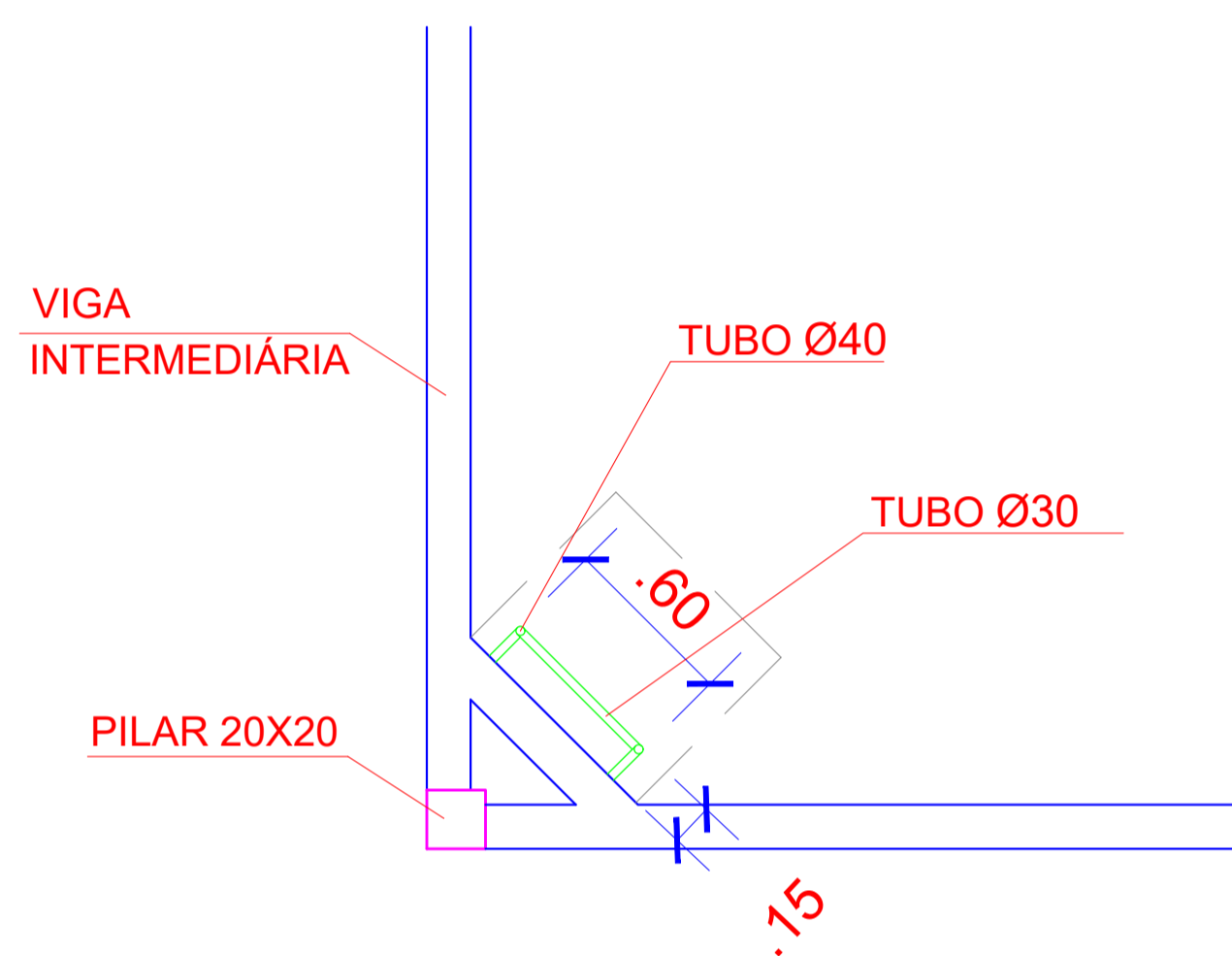

PLANTA INFERIOR
ESCADA MARINHEIRO
ESCALA 1/25

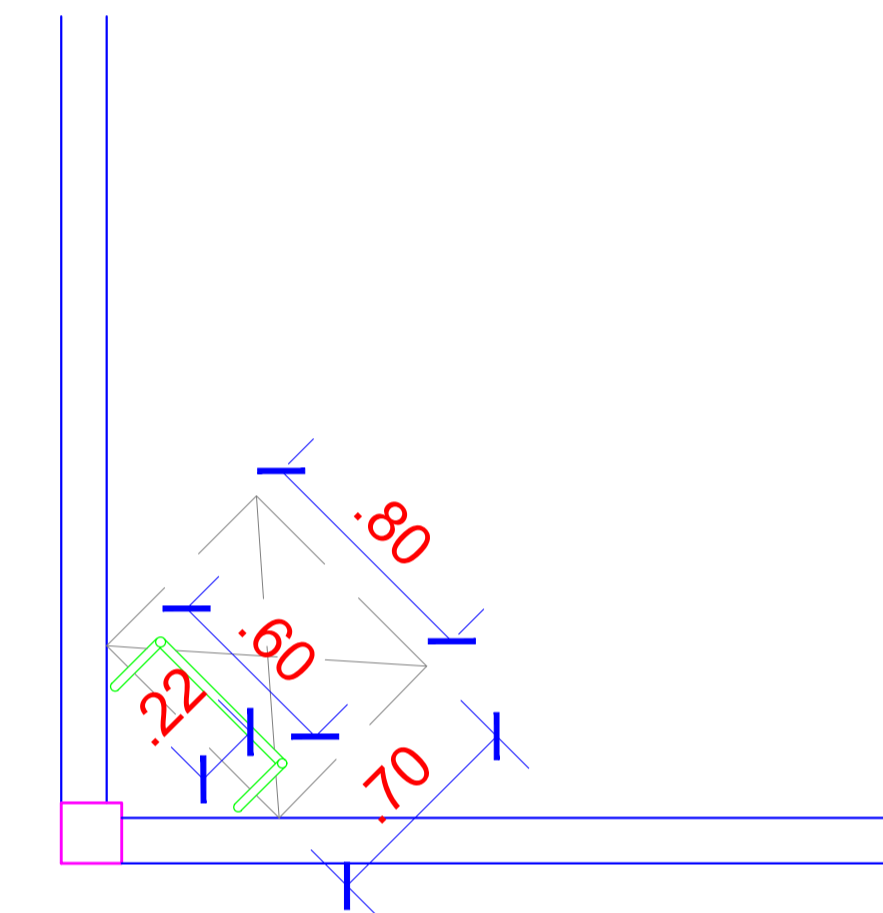

PLANTA SUPERIOR
ESCADA MARINHEIRO
ESCALA 1/25

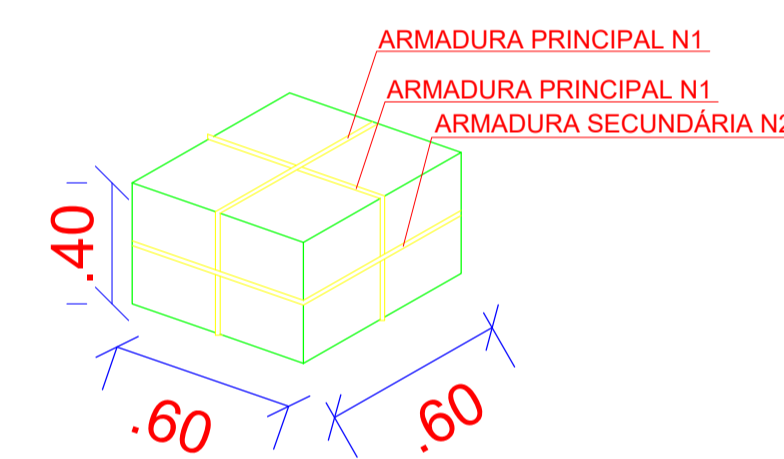

DETALHE ESTRUTURAL
CAIXA D'ÁGUA
ESCALA 1/50

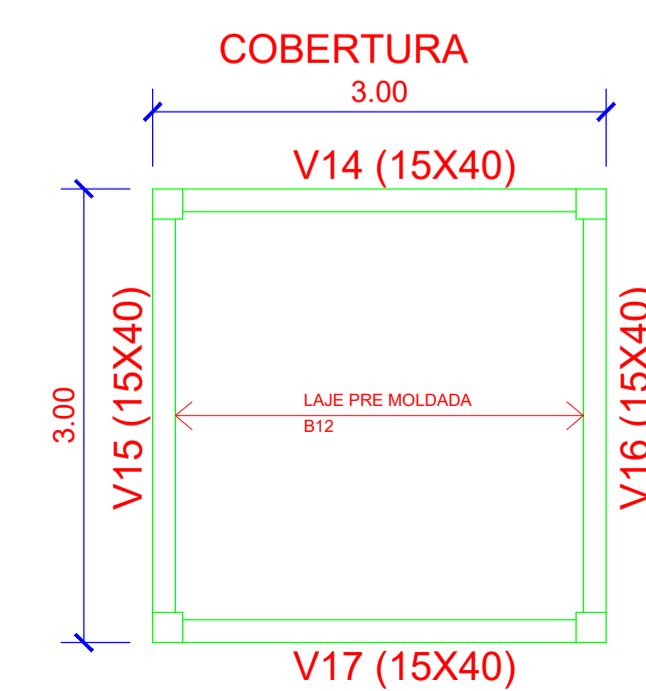
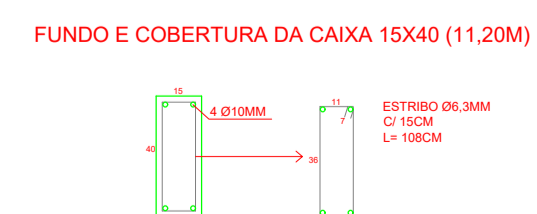
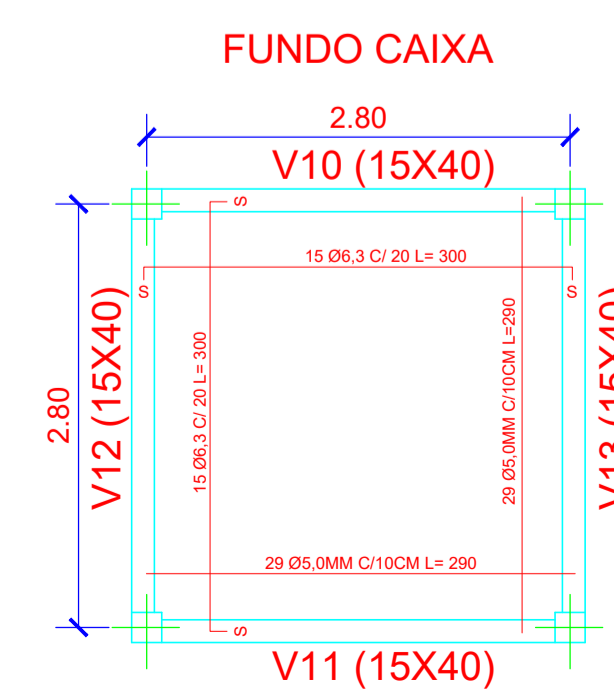
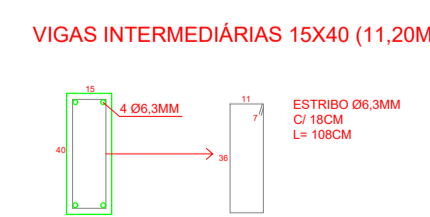
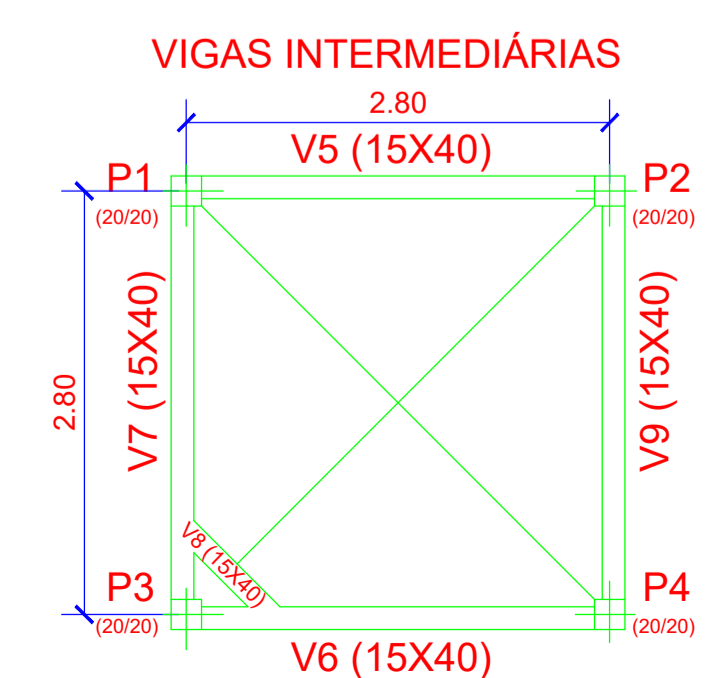
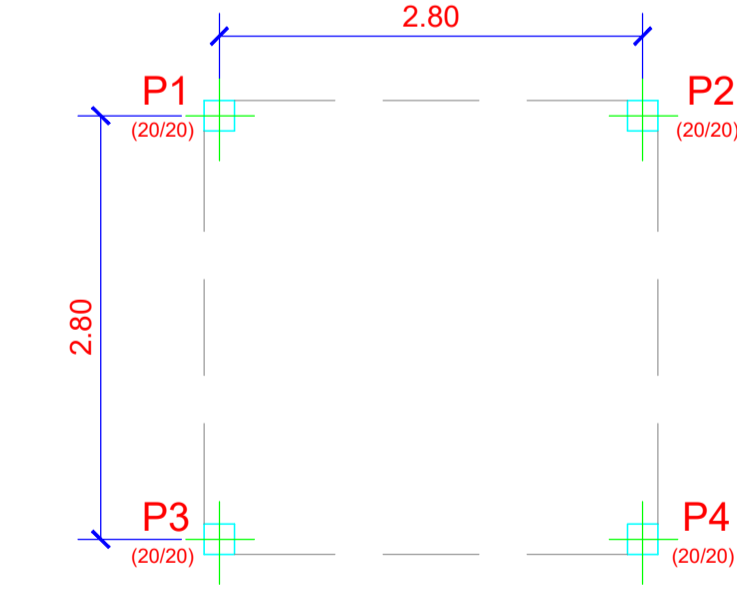
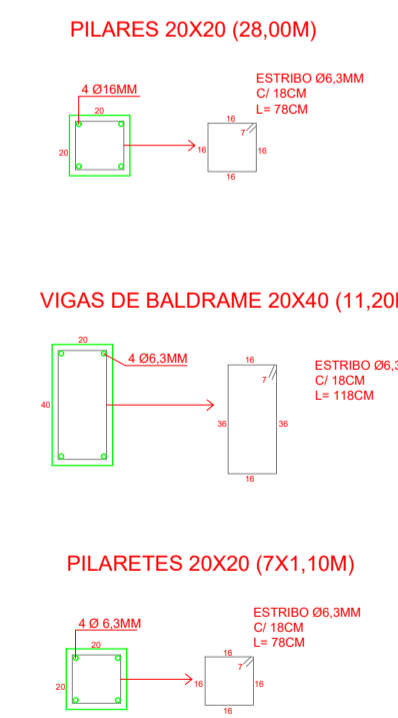
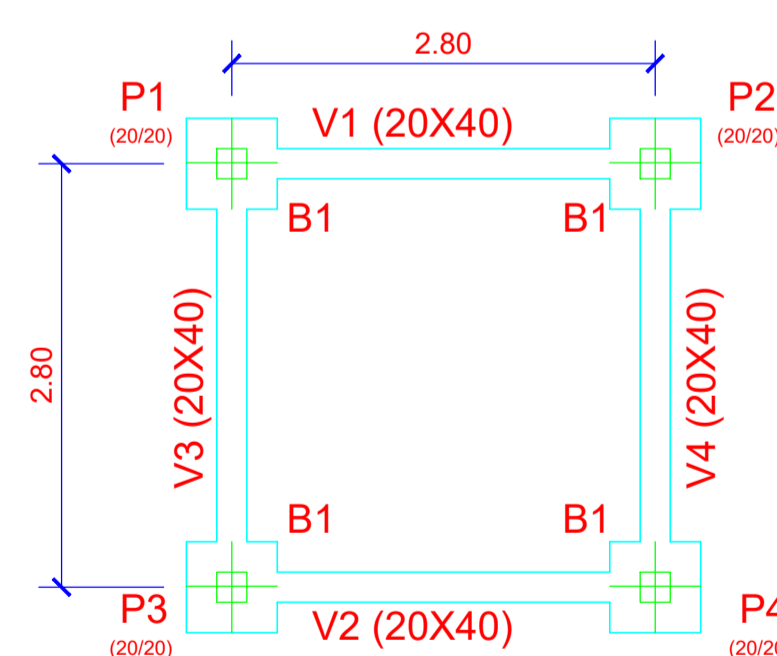

CARIMBOS E APROVAÇÕES:

MUNICÍPIO DE DESCANSO
Descanso, lugar bom de viver!

GINÁSIO MUNICIPAL ERVINO MAZZARDO

RUA JOSÉ PIETROSKI, Nº222 CENTRO DE DESCANSO

INDICADA	FERNANDO TRINTINAGLIA	06/08/2019
ÁREA TOTAL DO LOTE: 26.013,00M ²	ÁREA TOTAL DA EDIFICAÇÃO: 1.914,53M ²	
DETALHAMENTO TORRE DA CAIXA D'ÁGUA		
FERNANDO TRINTINAGLIA - CREA/SC 140.621-5		08/20